



USER MANUAL

SHORT-CIRCUIT LOOP IMPEDANCE METER

MZC-310S



USER MANUAL

SHORT-CIRCUIT LOOP IMPEDANCE METER MZC-310S



**SONEL SA
Wokulskiego 11
58-100 Świdnica
Poland**

Version 3.9 03.10.2023

TABLE OF CONTENTS

1 Preface	4
2 Introduction	4
3 Safety	5
4 Device description and its functionality	5
4.1 MZC-310S characteristics	5
4.2 Terminals and keys layout	6
4.2.1 Terminals	6
4.2.2 Keyboard	7
4.3 Graphical display panel (LCD)	8
4.4 Buzzer	10
4.5 Test leads	11
5 Before you start	11
6 Operations	12
6.1 Preparing the device for work	12
6.2 Power supply voltage monitoring	12
6.3 Battery replacement	13
6.4 Conditions for performing tests and obtaining correct results	14
6.5 Device connection diagrams	15
6.6 Measurement of alternating voltage	20
6.7 Short-circuit loop measurement	20
6.7.1 Measurement of network voltage and frequency	21
6.7.2 Changing the network rated voltage	21
6.7.3 Displaying all measurement results or the main result only	21
6.7.4 Displaying the measurement results in terms of impedance or short-circuit current	21
6.7.5 Measurement of touch voltage U_{ST} and touch shock voltage U_T	22
6.7.6 Selection of test cables length (for measurements using two-pole method)	23
6.7.7 Results display	23
6.7.8 Measurement of short-circuit loop parameters using two-pole method	24
6.7.9 Measurement of short-circuit parameters by the four-pole method	24
6.8 Measurement of earthing resistances	25
6.9 Saving the measurement results	27
6.9.1 Storing measurement results in the memory	27
6.9.2 Memory browsing	28
6.9.3 Erasing the memory	28
6.10 Menu	29
6.10.1 Display contrast adjustment	29
6.10.2 Data transmission	29
6.10.3 Display settings	30
6.10.4 Loop measurement settings	30
6.10.5 Language selection	30
6.10.6 Advanced functions	31
a. Expected declension of results	31
b. Upgrading the software	32
6.10.7 Information about the manufacturer and the software	32
6.11 Sending data to a computer	32
6.11.1 Communications kit	32
6.11.2 Connecting the meter to a computer	33

7	Troubleshooting	33
7.1	Warnings and information displayed by the meter	33
7.1.1	Exceeding the measurement range	33
7.1.2	Battery status display	33
7.2	Self-test error messages	33
7.3	Before you send the device for repairs	34
8	Cleaning and maintenance	34
9	Storage	34
10	Decommissioning and recycling	34
11	Technical specifications	35
11.1	Basic data	35
11.2	Other technical data	37
12	Manufacturer	37

1 Preface

Thank you for purchasing our short-circuit loop impedance meter. MZC-310S is a state-of-the-art, high-quality measuring instrument that is easy and safe to operate. However, familiarising with this manual will let you avoid measurement errors and will prevent possible problems that might occur while operating the device.

In this instruction we use three types of warnings. They are shown as a framed text and describe possible hazards for either the user of the device. Texts that start with the word "**WARNING:**" describe a life threatening or hazardous situation that can result if the instructions are not followed. Wherever a "**NOTE!**" exclamation opens the framed text, it describes a situation where non-adherence to the manual can result in damage to the meter. Possible problems that may occur are preceded with .



WARNING

- Before starting to use the device, please read carefully this manual, always follow all health and safety rules and comply with manufacturer's recommendations.
- MZC-310S meter is designed to measure short-circuit loop impedance and alternating voltages. Using the device for purposes other then described in this manual can cause an injury to the operator and/or can damage the device.
- MZC-310S may be used only by qualified personnel who is certified to work with electrical installations. Operating the instrument by a person who is not qualified, can result in a hazardous situation and/or can cause damage to the meter.
- Using this manual does not exclude the need to comply with occupational health and safety regulations and with other relevant fire regulations required during the performance of a particular type of work. Before starting the work with the device in special environments, e.g. potentially fire-risk/explosive environment, it is necessary to consult it with the person responsible for health and safety.



An attempt to install drivers in 64-bit Windows 8 may result in displaying "Installation failed" message.

Cause: Windows 8 by default blocks drivers without a digital signature.

Solution: Disable the driver signature enforcement in Windows.

2 Introduction

This manual describes the MZC-310S short circuit loop meter. We recommend that you familiarize yourself thoroughly with the contents of this manual in order to avoid errors that can result in a safety hazard or in an incorrect assessment of tested installations. More information related to safety issues can be found in chapter **3 – Safety**. Before you use the device for the first time, read carefully chapter **5 – Before You Start**. If the device causes any problems, refer to chapter **7 – Troubleshooting**. All information on how to use the device is located in chapter **6 – Operations**.

3 Safety

MZC-310S device is intended for testing electric shock protection and grounding in AC power networks. Results obtained from readings determine the safety status of installations. Therefore, to ensure correct operations of the device and reliability of measurements, you need to adhere to the following rules:

- Before starting to use the meter, you have to become thoroughly familiar with this manual.
- The device should be operated only by persons holding appropriate qualifications and who attended appropriate occupational health and safety training.
- It is not acceptable to:
 - ⇒ Use the meter that is damaged in any way
 - ⇒ Use leads with damaged insulation
 - ⇒ Use a meter stored in inappropriate conditions (e.g. high humidity) for a prolonged period of time
- Before commencing a measurement, select the desired mode and make sure that the test leads are connected to the appropriate terminals.
- Repairs can be performed by an authorised service agent only.

Additional points to remember:

- The text **BAT!** appearing in the right upper corner of the display (instead of the battery symbol) indicates insufficient power supply voltage and signals a need to replace the batteries.
- Measurements made with the meter with the supply voltage being too low are burdened with some additional errors that are impossible for the user to evaluate and therefore must not be relayed upon when assessing if the installation tested is sufficiently protected.

4 Device description and its functionality

4.1 MZC-310S characteristics

MZC-310S is designed to measure short-circuit loop impedance and alternating voltages.

Main features of MZC-310S.

- Measurement of very low short-circuit loop impedances with a current of 150A at 230V, maximum 280A at 440V ($R_{zw} = 1,5\Omega$)
- Touch voltage and touch shock voltage measurement
- Ability to perform a measurement with a current of 23A at 230V, maximum 42A at 440V ($R_{zw} = 10\Omega$)
- Measurements in installations with rated voltages between 220/380V and 230/400V and frequencies 45...65Hz
- Selection of rated voltage: 220V/380V or 230V/400V
- Ability to perform measurements in short-circuit system: phase-phase, phase-protective, phase-neutral
- Automatic calculation of the short-circuit current
- Differentiation between the phase voltage and the inter-phase voltage while calculating the short-circuit current
- Automatic choice of measurement range
- Ability to change the length of measurement cables without a need to re-calibrate the instrument
- Measurement of alternating voltages
- Memory to store 990 measurement results with an ability to transfer them to PC via an RS-232C connection
- Large, legible LCD with a backlit option
- Monitoring battery's charge status
- Automatic switch-off when the instrument is not used (AUTO-OFF)
- Ergonomic design

4.2 Terminals and keys layout

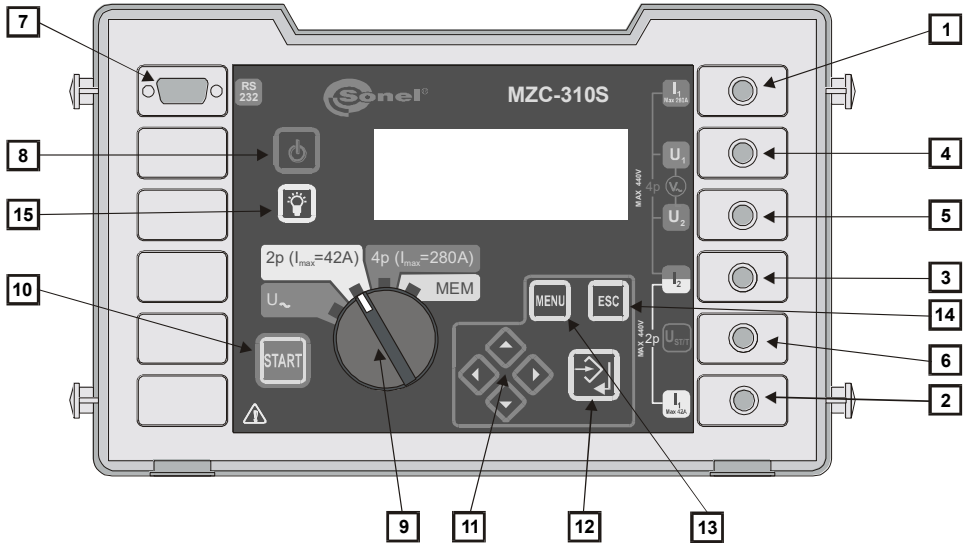

Fig.1. MZC-310S front panel layout

4.2.1 Terminals



NOTE!

- MZC-310S is designed to operate at rated phase voltages of 220V and 230V and inter-phase voltages of 380V and 400V.
- Applying voltages higher than those specified to any of the test terminals can damage the device

1 Test terminal I_1 (I_{max} 280A)

Terminal to connect the phase current cable in the four-pole method of the short-circuit loop impedance measurement using current not exceeding 280A.

2 Test terminal I_1 (I_{max} 42A)

Socket to connect the phase current cable in the two-pole method of the short-circuit loop impedance measurement using current not exceeding 42A.

3 Test terminal I_2

Terminal (common for both methods) to connect the neutral cable N, protective cable PE/PEN (current cable in the four-pole method) or another phase cable in a case of a short-circuit loop impedance measurement in the phase-phase configuration.

4 Test terminal U_1

Terminal to connect the voltage phase cable in the four-pole method of short-circuit loop impedance measurement or a cable to measure alternating voltage.

5 Test terminal U_2

Terminal to connect the voltage neutral cable N or the protective cable PE (PEN) in the four-pole method of short-circuit loop impedance measurement or the cable to measure alternating voltage.

6 Test terminal $U_{ST/T}$ (U_B)

Terminal to connect the protective cable PE (PEN) in the function of touch voltage U_{ST} measurement or an electrode (probe) in the touch shock voltage U_T measurement mode.

7 Test terminal RS-232C

Terminal to connect a serial communications cable (RS-232C).

4.2.2 Keyboard

8 Key 

Switching the device power supply on and off.

9 Rotary mode switch

Selection of measurement function:





- U_{\sim} - measurement of alternating voltage
- **2p ($I_{max}=42A$)** – measurement of short-circuit loop impedance by the two-pole method using a current not exceeding 42A (short-circuit resistor $R_{ZW} = 10\Omega$)
- **4p ($I_{max}=280A$)** – measurement of short-circuit loop impedance by the four-pole method using a current not exceeding 280A (short-circuit resistor $R_{ZW} = 1.5\Omega$) and touch voltage measurement
- **MEM** – memory browsing

10 Key 

Starting the measurement of short-circuit loop impedance or short-circuit current.

11 Keys 

Set of cursor keys with auto-repetition function activated by holding the key depressed:

- ,  - Selection of an option vertically, change of the bank number
- ,  - Selection of an option horizontally, change of the cell number

12 Key 

- Confirmation of selected option
- On completing of the measurement:
 - Start of the memory write mode
 - In the memory write mode – storing the measurement result in the selected cell

13 Key 

Selection of additional functions:

- Display contrast adjustment
- Starting the data transmission mode
- Setting the measurement and display parameters
- Language selection
- Advanced functions
- Manufacturer and software info

14 Key 

- Exit from selected option
- Return to the previous screen

15 Key 

Switching the LCD illumination on and off.

4.3 Graphical display panel (LCD)

16  - Device overheating (symbol replaces “READY” flag)

17  - Battery status

18  - Battery low – needs replacement.

19  - Sending results to the memory.

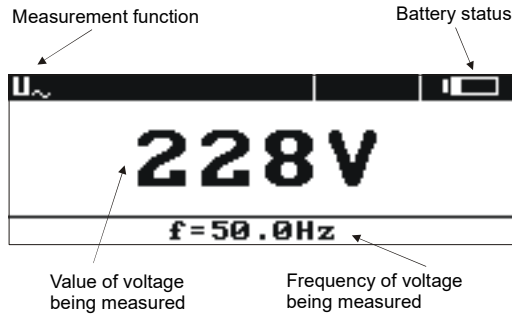

Fig.2. Screen layout in alternating voltage measurement mode

Bank and cell number (in store-in-memory mode)
or the text “READY” advising about
the capability to make the measurement
or the temperature
excess symbol

Length of measurement cables for “2p”

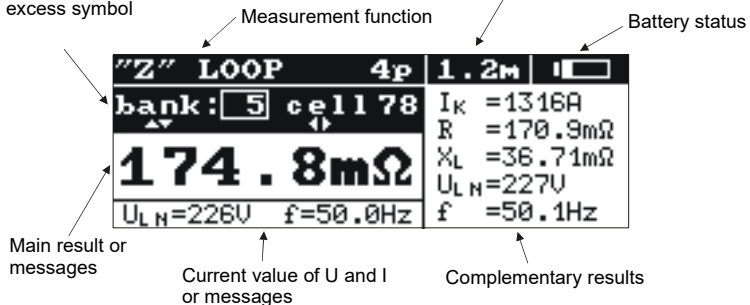

Fig.3. Screen layout in short-circuit loop impedance measurement mode (all results)

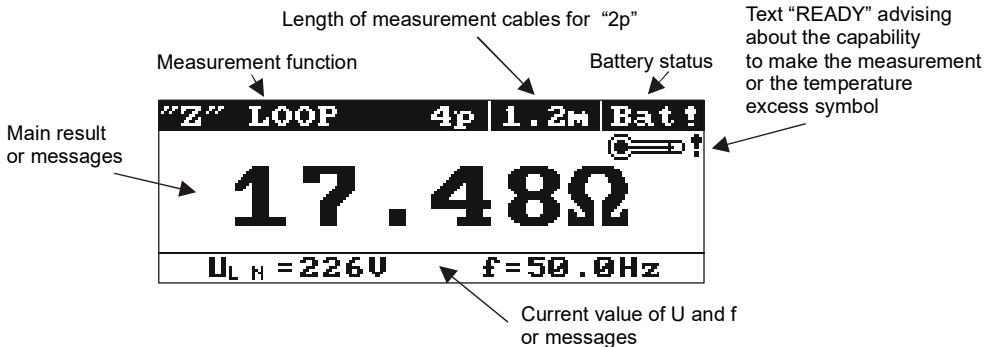

Fig. 4. Screen layout in short-circuit loop impedance measurement mode (main result only)

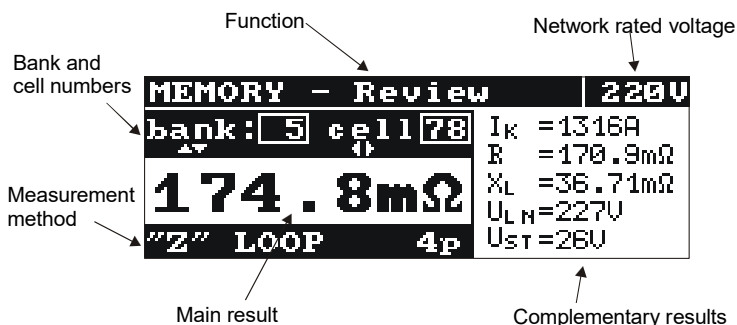

Fig.5. Screen layout in the memory browse mode

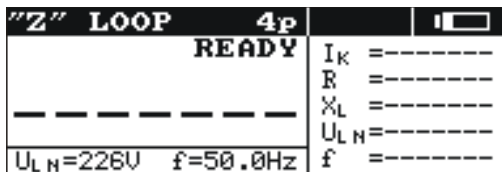

Fig.6. Screen appearance after switching the meter on (loop impedance measurement – all results)

4.4 Buzzer

Warning signals:

Continuous beep

- The voltage applied to meter's terminals exceeds 440



NOTE!

Applying voltage that is higher than the permissible value can damage the device.

Long beep (0.5 sec)

- Key, that is inactive for the selected function, has been pressed.
- Device overheating (after the key **10** **START** has been pressed)

Two long beeps (after starting a measurement by pressing the **10** **START** key)

- Network frequency outside of the permissible range (45..65 Hz).
- Supply power voltage too low $U_x < U_{min}$
- Test leads connected incorrectly
- Voltage fading or measurement error.
- Short-circuit loop faulty.
- Measurement range exceeded

Confirmation and miscellaneous sounds:

Short sound

- Confirmation of a key being pressed and of a function being performed by the device.
- Transition from the greeting screen to a screen appropriate for the mode selected.
- Return to the home screen after displaying an error message.
- In **MEM** mode – return to the main menu after erasing a cell, a memory bank or the entire memory.
- Ready to perform a measurement (displaying **READY**)

Long sound (0.5 sec)

- Signals turning the device ON
- Signals that the meter has automatically switched off

Three short sounds

- Measurement result stored in the memory
- Confirmation of new MENU settings
- Cell, bank or the entire memory erasure confirmation

4.5 Test leads

MZC-310S short-circuit loop meters using a 2p method are factory calibrated to compensate for the resistance of the proprietary test leads that are supplied in the following lengths:

cable L:

- 1.2m

cable PE/N:

- 1.2m
- 5m
- 10m
- 20m

Cables used for measurements using the four-pole method do not require calibration. However, they have to ensure an undisturbed flow of high currents.



WARNING

Connecting unsuitable or faulty cables can cause an electrical shock.



- The manufacturer guarantees correct readings only if the original leads supplied with the device are used and if the correct length (for 2p method) has been selected in the MENU. Extension leads or third party cables can be a source of additional errors.
- Symbol “CAT III 1000V” shown on accessories is equivalent to the symbol “CAT IV 600V”.

5 Before you start

After the purchase:

- Check the contents of the packaging
- Insert batteries
- Verify and if necessary modify instrument's configuration (method of displaying results, network rated voltage, measurement of touch voltage, length of cables in the 2 p method)

6 Operations

You need to get familiar with this chapter as it describes test diagrams, testing methods and basic rules of interpreting obtained results.

6.1 Preparing the device for work

Before commencing the measurements:





- Make sure that the battery condition will allow you to complete the task
- Check if the meter's housing and leads' insulation are not damaged



WARNING

- Using test leads with damaged insulation can cause electrocution.
- Do not use a device that was stored for a prolonged period of time in unsuitable (e.g. humid) conditions.
- You must not use the device with open or partially closed battery compartment and you must not use any power source other than specified in this manual.
- You must not leave disconnected leads while some of them remains connected to the tested installation.
- You must not leave the device unattended while it is connected to the tested installation.
- You must not touch appliances connected to the tested installation.
- You must not use the device if you notice that a loose object is present inside (the device is rattling when shaken).
- Do not insert any objects into the device through the fan mesh nor use the device if an object was placed inside.



If the display is totally illegible, press down the keys **13**  and **12**  and adjust the contrast using the keys  and .

6.2 Power supply voltage monitoring

The battery charge is shown by the indicator located in the upper right corner of the display as shown in Fig.7.

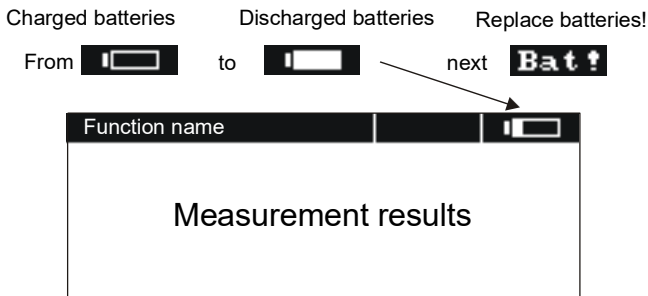

Fig.7. Battery charge indicator

6.3 Battery replacement

MZC-310S meter is supplied with five R14 batteries (alkaline batteries are recommended) that should be placed in the battery compartment located in the bottom part of the meter's housing.



WARNING

Leaving the leads attached to the terminals can result in a life threatening electrocution.



NOTE!

If the batteries leaked inside the compartment, the device should be sent to an authorised service agent.

When the symbol  is displayed, it signals that the batteries are discharged. Replacement of the batteries is then necessary. To do it you need to:

- Disconnect all leads from the terminals
- Remove the battery compartment lid
- Replace all batteries. The batteries (5xR14) should be inserted as shown on the diagram inside the compartment. Incorrectly installed batteries will not damage the device or the batteries but will prevent the meter from functioning
- Replace the lid and secure it with screws.

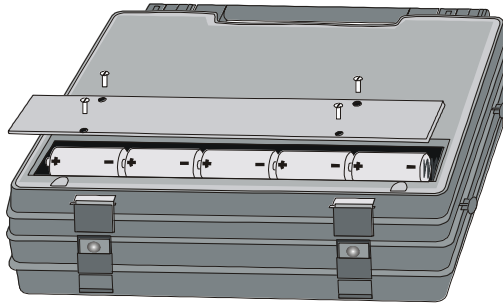



















Fig. 8. Opening the battery compartment

6.4 Conditions for performing tests and obtaining correct results

To start a test sequence a number of conditions have to be fulfilled. The device will automatically prevent a test from commencing (except for voltage measurement) if any of the conditions listed below is not satisfied:

Situation	Displayed symbols and warning signals	Remarks
The voltage applied to meter's terminals exceeds 440V.	Text: U > 440V! and a continuous beep produced.	Immediately disconnect the meter from the tested installation!
The voltage frequency in the installation is outside of the range 45..65Hz.	Texts: Error! and: f<45Hz or f>65Hz Two long beeps	The text appears and a sound signal is produced when the key   is pressed
The voltage applied to meter's terminals is too low to measure the impedance.	Texts: Error! and: U_B<180V or U_B<190V Two long beeps	The text appears and a sound signal is produced when the key   is pressed.
Improperly connected cable I1: in 4p method to socket I1(42A) or in 2p method to socket I1(280A)	Texts: Cables connected improperly! and: Terminal I1(42A)! or Terminal I1(280A)! Two long beeps	The text appears and a sound signal is produced when the key   is pressed
Cables I1 or I2 are not connected (in the 4p method).	Text: No voltage on terminals I1, I2! Two long beeps	The text appears and a sound signal is produced when the key   .
In the 4 p method, cables U or I swapped, or connected to different phases	Text: Different voltage phases on terminals U and I! Two long beeps	The text appears and a sound signal is produced when the key   is pressed
Improperly connected cable U _B with the set option of touch voltage measurement	Texts: Incorrectly connected cable! and: Terminal U_B! Two long beeps	The text appears and a sound signal is produced when the key   is pressed
While measuring the loop impedance a voltage drop below U _{min} took place.	Text: Voltage failure while measuring! Two long beeps	
While measuring the loop impedance a situation preventing completion of the measurement occurred.	Text: Error while measuring! Two long beeps	
While measuring the loop impedance the fuse was burnt or another emergency situation in the current circuit occurred.	Text: Short circuit loop faulty! Two long beeps	
Thermal protection prevents the measurement.	Displayed symbol  Long beep	A sound signal is produced when the key   is pressed
Exceeded measurement range	Inscription: OFL Two long beeps	
Discharged batteries	Displayed symbol  	Making the measurements is still possible, however, the user should take into account some additional errors.



Displayed warnings stay on the screen for 3 seconds.

6.5 Device connection diagrams



NOTE!

The meter is connected to the tested installation as shown in Figures 9 -19. Attention should be paid to the correct selection of test terminals since the precision of the measurements being performed depends upon the quality of connections made. They have to provide a good contact and allow for undisturbed flow of high current measured. For instance, it is unacceptable to clip the crocodile connectors onto oxidized or corroded points – they have to be either cleaned beforehand, or the test needle tip probe should be used for measurements.

The device is to be connected to a tested installation or appliance in the way shown in fig. 9-19.

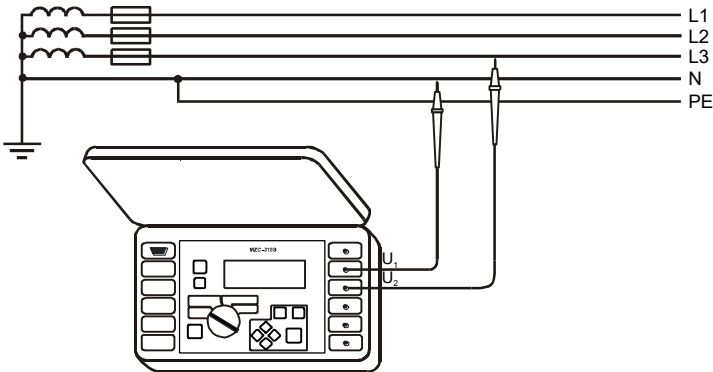

Fig.9. Alternating voltage measurement

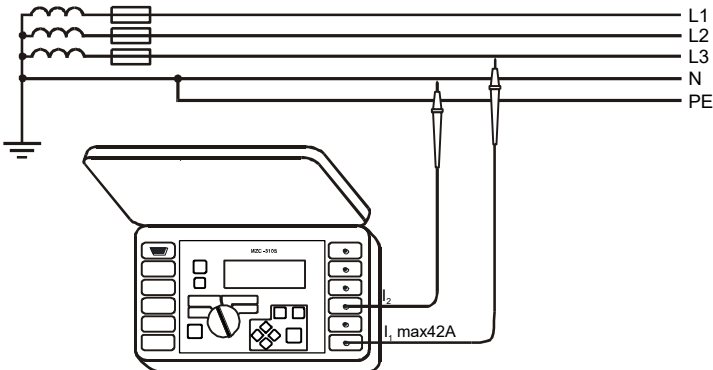

Fig.10. Measurement of impedance in working circuit (L-N) using two-pole method

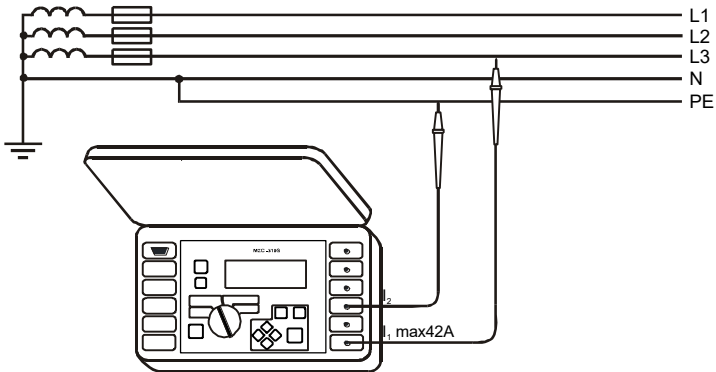

Fig.11. Measurement of impedance in protective circuit (L-PE) using two-pole method

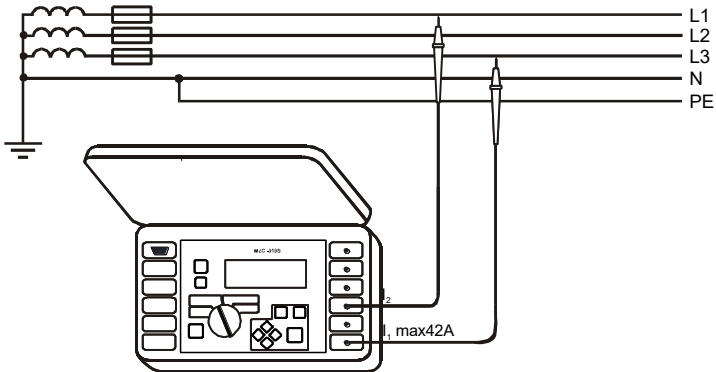

Fig.12. Measurement of impedance in working circuit (L-L) using two-pole method

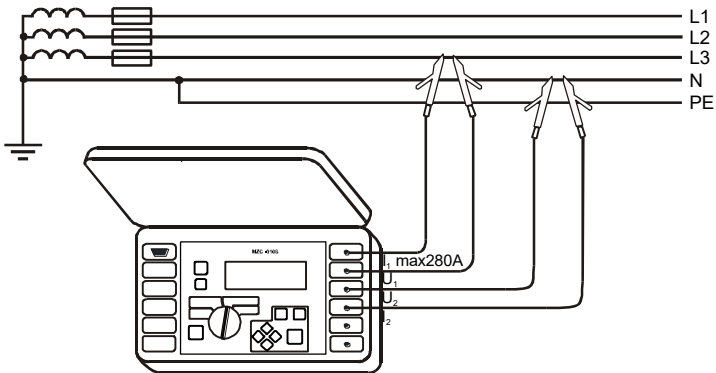

Fig.13. Measurement of impedance in working circuit (L-N) using four-pole method

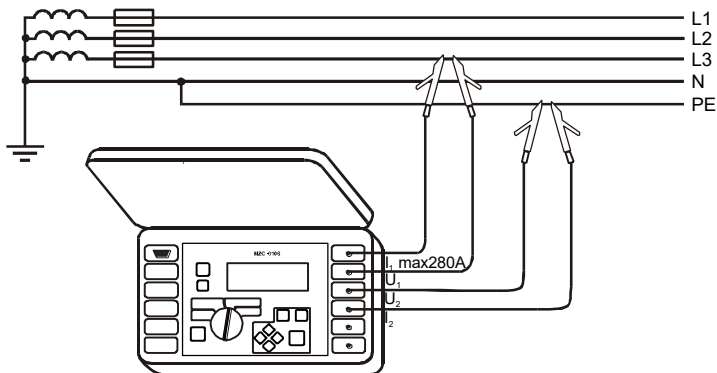

Fig.14. Measurement of impedance in protective circuit (L-PE) using four-pole method

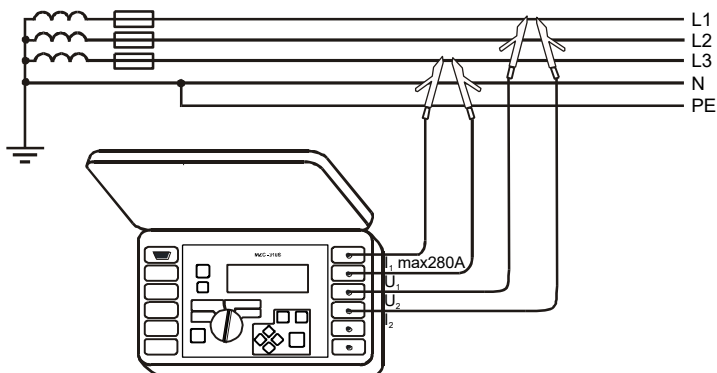
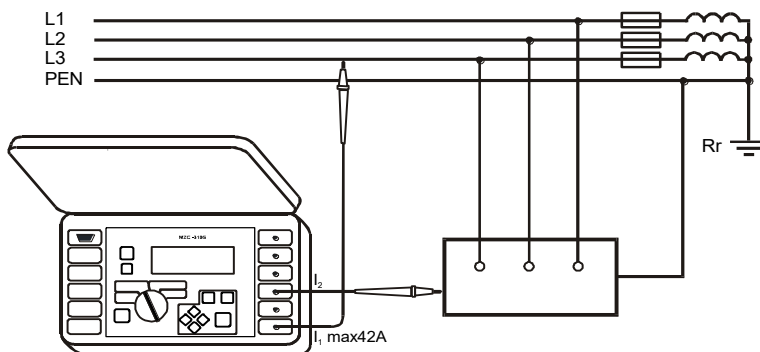

Fig.15. Measurement of impedance in working circuit (L-L) using four-pole method

a)



b)

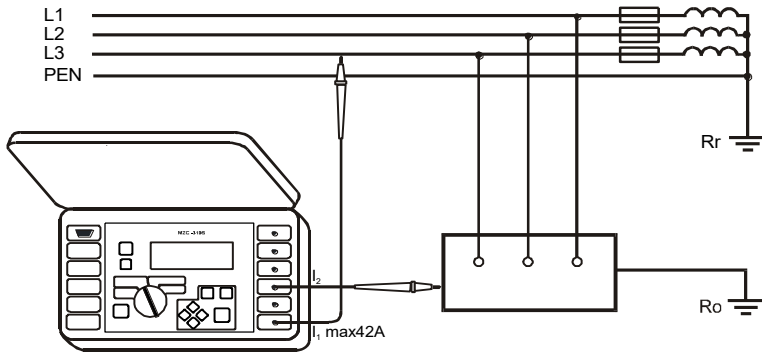
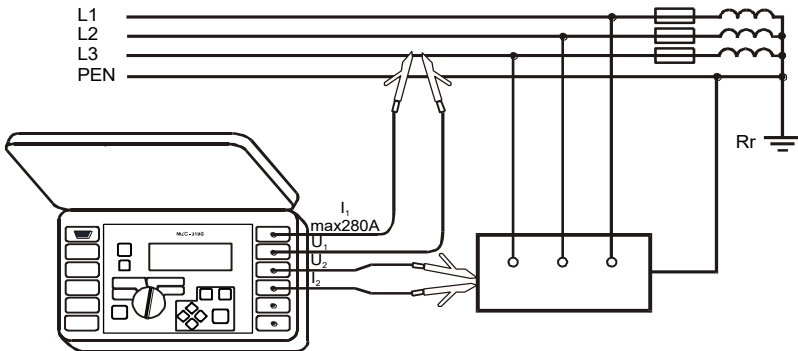

Fig.16. Verification of anti-shock protection reliability of appliance's housing using two-pole method for: a) TN networks b) TT networks

a)



b)

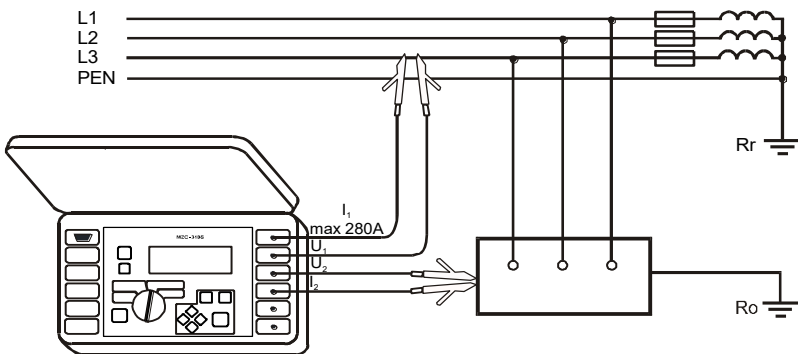

Fig.17. Verification of the anti-shock protection reliability of appliance's housing using four-pole method for: a) TN networks b) TT networks

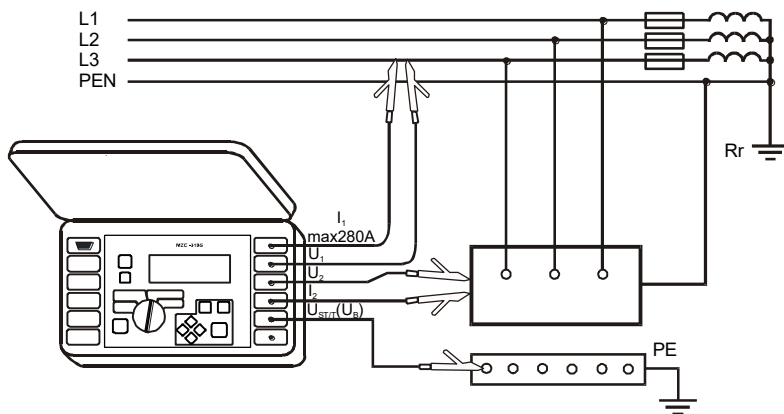

Fig.18. Measurement of touch voltage U_{ST}

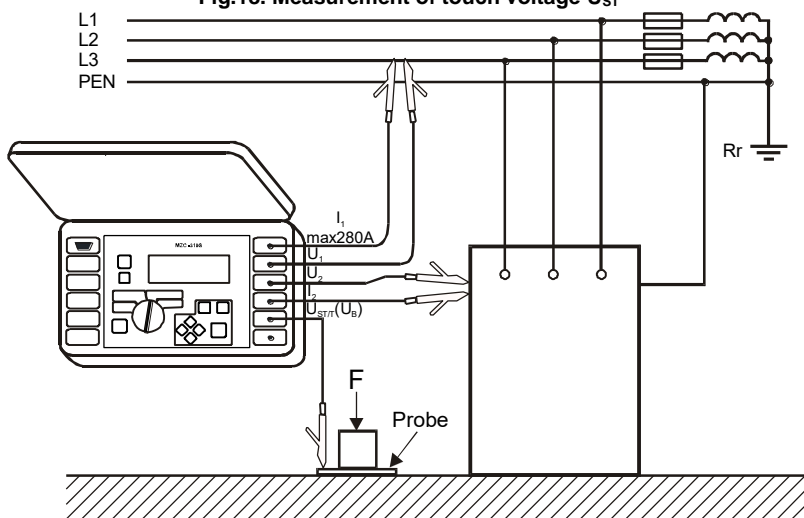

Fig.19. Measurement of shock voltage U_T

6.6 Measurement of alternating voltage



NOTE!

Applying voltage in excess of 440V to any of the test terminals may damage the device.

To measure alternating voltage:

- Connect the test cables to sockets: **4** U_1 and **5** U_2 (Fig.9)
- Set the rotary switch **9** to position U_{\sim}

The measurement result is displayed as shown in Fig.2.

The instrument measures alternating voltage with the frequency between 45Hz and 65Hz as True RMS without separating a possible constant component. Voltage with the frequency lower than 45Hz is measured as direct voltage. If the frequency of the run being measured is not included within the specified limits, instead of its value an appropriate message is displayed: **f<45Hz** or **f>65Hz**.

6.7 Short-circuit loop measurement



WARNING

- **You must not leave disconnected leads while some of them remains connected to the tested installation.**
- **You must not leave the device unattended while it is connected to the tested installation.**
- **You must not touch appliances connected to the tested installation.**



NOTE!

If the tested installation includes RCD circuit breakers, you should bridge them for the duration of the test. You should keep in mind however that doing so you modify the tested circuit and consequently the results can marginally differ from the expected results. Remember to remove any modifications of the installations that were introduced and check the functioning of the RCD circuit breakers.





- Measurements of fault loop impedance performed downstream of inverters are ineffective and their results are unreliable. This is due to the instability of internal impedance in inverter circuits during its operation. The measurements of fault loop impedance should not be performed directly downstream of inverters.
- Performing a large number of consecutive measurements in short intervals can cause the resistor limiting the current flowing through the device to produce large amounts of heat which in turn can cause the device's housing to become hot. This is quite normal. The device has a built-in overheating protection.
- During measurements with a current of an order of 280A, the instrument, if necessary, activates a fan that reduces the instrument cool-down time.
- The minimum time interval between successive measurements is 5 seconds. The text „START” displayed on the screen informs the user that the device is ready to perform the measurement.

6.7.1 Measurement of network voltage and frequency

In the short-circuit loop parameters measurement (2p or 4p) mode, the instrument constantly monitors the network voltage and frequency in the way described in section 6.6. Their values are displayed at the bottom of the screen. Index attached to the voltage U symbol informs the user whether the phase voltage - U_{LN} , or the inter-phase voltage - U_{LL} is measured, or whether the voltage value exceeds the ranges shown in Fig.19. - U_{Σ} . The same rules to determine the voltage type apply to the voltage measured while measuring the short-circuit loop impedance.



6.7.2 Changing the network rated voltage

The rated voltage is used to compute the short-circuit voltage value. In order to set the voltage rated value do the following:

- Press down the key  
- Select **Loop measurement settings**
- In the item **$U_n[V]$** select and store the rated voltage value (see section 6.10.3 *MENU*)



6.7.3 Displaying all measurement results or the main result only

In order to choose between displaying all measurement results or the main result only (Z_s or I_k) you need to:

- Press the key  
- Select **Display settings**
- In the item **Results**, select and store the option required (see section 6.10.3 *MENU*)

6.7.4 Displaying the measurement results in terms of impedance or short-circuit current

The main result of the measurement can be displayed as a short-circuit loop impedance or a short-circuit current. If the impedance has been selected, the first of the auxiliary results will be the current, otherwise it will be the impedance (Fig.3). To select the value to be displayed you need to:

- Press the key  
- Select **Display settings**
- In the **Main result** option select and save the value type to be displayed (impedance or current) (see section 6.10.4 *MENU*)

The device always measures impedance, and the short-circuit current displayed is calculated from the formula:

$$I_k = \frac{U_n}{Z_s}$$

where: U_n – rated voltage of the network being tested, Z_s – impedance measured.

The meter automatically recognizes the measurement for inter-phase voltage (380V or 400V) and takes it into account in calculations.

In a case when the installation voltage is outside of tolerance, the meter will not be able to determine the rated voltage for the short-circuit current calculation. In such event the display will show horizontal dashes instead of the short-circuit current value. Fig. 7 shows voltage ranges for which the short-circuit current is calculated.

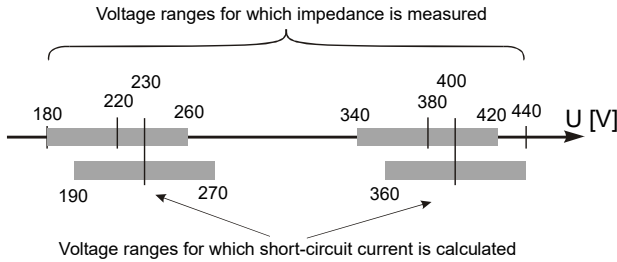

Fig. 20. Relationship between the network voltage and the ability to calculate the short-circuit current

Further in this document the term „impedance measurement” will refer to performing the measurement and displaying the result in terms of current or impedance.

6.7.5 Measurement of touch voltage U_{ST} and touch shock voltage U_T



Touch shock voltage U_T as measured by the meter applies to the network rated voltage for which the measurement was made. For other rated voltages the result displayed should be converted.

In order to measure touch voltage U_{ST} or touch shock voltage U_T you need to:

- Press the key **13** **MENU**
- Select **Loop parameters settings**
- In the item **Measurement (4p)**, select **U_{ST}** or **U_T** and save the selection (see Paragraph 6.10.4 **MENU**)
- Connect test leads as in Fig.18 for U_{ST} or as in Fig. 19 for U_T .



If touch voltage is not measured, the user should, in MENU item „Measurement (4p)”, select and save the „- -” option. Otherwise the displayed values will not be correct since they can induce interfering voltages in unconnected socket $U_{ST/T}$ (U_B).

The value of touch voltage U_{ST} (or touch shock voltage U_T), being the value referred to the anticipated short-circuit current calculated from the formula as presented in section 6.7.4., is displayed instead of frequency in the auxiliary results field (Fig.21).

The measurement of touch shock voltage U_T is performed after introducing an additional resistor (inside the device) of 1k Ω between the terminals U_2 and $U_{ST/T}$ (U_B). The resistor simulates resistance of the human body, while the terminal $U_{ST/T}$ (U_B) is to be connected to the probe that simulates human feet located on the ground (Fig.19), whose properties and load are described by relevant standards.

6.7.6 Selection of test cables length (for measurements using two-pole method)

Before starting a measurement, a correct length of test leads should be selected.



NOTE!

Using the proprietary test leads and the correct length selection guarantees that the declared accuracy of measurements will be maintained.



It is assumed that only one test lead has the length selected in the MENU. The other one is always 1.2m in length. Non-compliance with this assumption will cause additional measurement errors (test leads resistance is always taken into account by the device).

In order to select the length of cables, you need to:

- Press the key **13** 
- Select **Loop measurement parameters**
- In the item **Cable 2p [m]**, select and save an appropriate value (see section 6.10.4 **MENU**)

6.7.7 Results display

If display of all results was selected, the short-circuit impedance Z_S or expected short-circuit current I_K is shown as the main result. On the right hand side of the screen the measurement components are displayed:

- Short-circuit current $I_{K \text{ or } Z_S}$
- Resistance R
- Reactance X_L

As well as:

- Mains voltage at the time of the measurement (U_{LN} , U_{LL} , U_{LPE} or U_{-})
- Frequency at the time of the touch (shock voltage) measurement

An example of a display after a short-circuit loop measurement was performed is shown in fig. 21.

"Z" LOOP 4p			
174.8mΩ		$I_K = 1316A$	
		$R = 170.9mΩ$	
$U_{LN} = 228V$ $f = 50.0Hz$		$X_L = 36.71mΩ$	
		$U_{LN} = 227V$	$f = 50.1Hz$

Fig.21. Displaying the results of short-circuit loop parameters measurement

If displaying of the main result only has been selected, the layout of the screen is as shown in Fig.4.

6.7.8 Measurement of short-circuit loop parameters using two-pole method

This is a measurement involving a current with a value of up to 42A (10 Ω short-circuit resistor, 200 Ω measurement scope). To make the measurement you need to:

- Connect the test cables to the sockets: **2** I_1 (I_{max} 42A) i **3** I_2 (Figs.10-12)
- Set the rotary switch **9** to the position **2p** ($I_{max} = 42A$)
- Press the key **10**

6.7.9 Measurement of short-circuit parameters by the four-pole method



WARNING

Use caution when operating the device as hot air that can be expelled by the built-in fan.

This is a measurement involving the current with a value of up to 280A (1.5 Ω short-circuit resistor, 2 Ω measurement range). It is specifically designed for circuits with very low short-circuit loop impedance. To make the measurement you need to:

- Connect the test cables in the following way (Figs.13-15):
 - Current cables to sockets: **1** I_1 (I_{max} 280A) and **3** I_2
 - Voltage cables to sockets: **4** U_1 and **5** U_2
- Set the rotary switch **9** to the position **4p** ($I_{max} = 280A$)
- Press the key **10**

6.8 Measurement of earthing resistances

MZC-310S can be used for rough measurements of earthing impedance and resistance. To do this, use the installation phase cable as an auxiliary voltage source – see Fig.22.

The measurement result is the sum of resistances of the earth electrode, working grounding, source and phase cable, thus it is burdened with a positive error. However, if it does not exceed the value allowable for the grounding being tested, the user may accept that the grounding has been made correctly and that there is no need to use more accurate measurement methods.

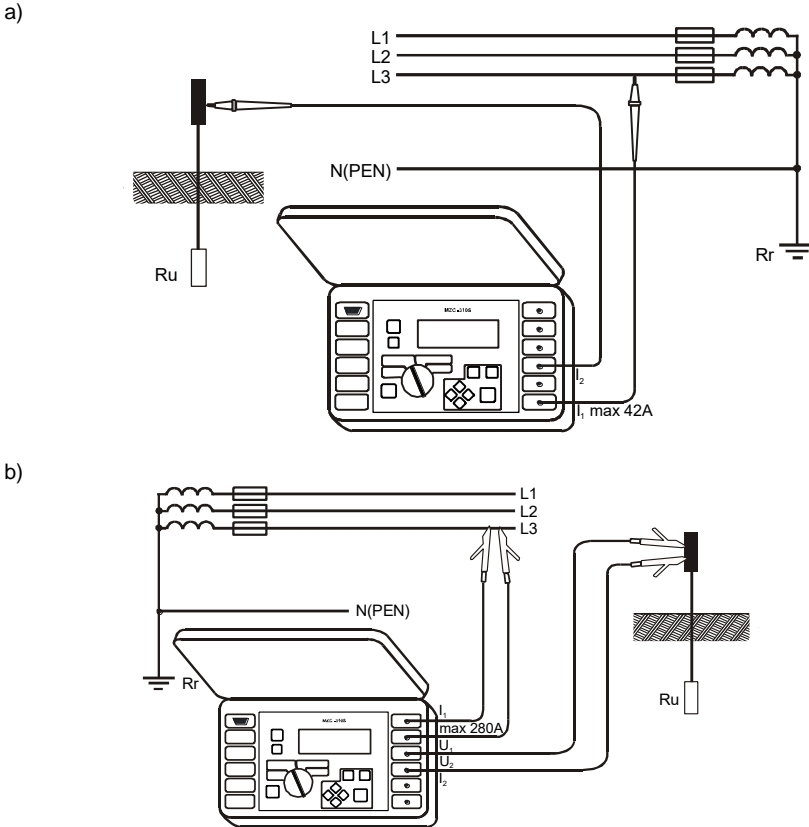
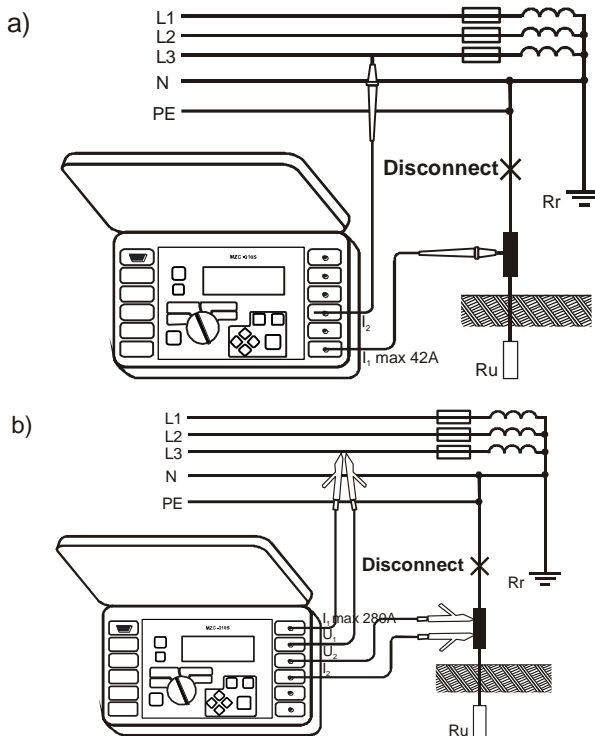

Fig.22. Method of connecting MZC-310S when measuring the grounding resistance for TN-C, TN-S i TT : a) using two-pole method b) using four-pole method

During earth resistance measurement it is necessary to familiarize with existing scheme of earth systems. To receive correct results, earth system should be disconnected from the network (N and PE cables). To measure earthing system in TN-C-S system and simultaneously to use the phase as the current source it is necessary to disconnect PE and N cable from measured earthing system. If such a incorrect results (test current will flow not only through the grounding system).



**Fig.23. MZC-310S connection diagram to be used when measuring the earth resistance for TN-C-S
a) using two-pole method b) using four-pole method**



WARNING

Disconnection of neutral and protective cables (N and PE) is dangerous for persons execute measurement and outside persons. It is obligatory to connect protective and neutral cables to the network immediately after measurements!

If disconnection is not possible need to be used meter from MRU family.

6.9 Saving the measurement results

MZC-310S devices have a built-in memory for storing up to 990 results of short-circuit loop parameters. A location in the memory where a single result is stored is called a memory cell. The whole memory is divided into 10 banks, each consisting of 99 cells. Every result can be stored in a cell with a specific address and in a selected bank. In this way the user can allocate the cell numbers to individual measuring points and the bank number to particular objects, make measurements in any sequence and repeat them without losing the other data.

The results storage is not erased when the meter is switched off. The data can be therefore retrieved at a later time or transferred to a computer. The address of the current cell or bank number does not change either.

It is recommended to erase the memory after the data has been read or before making a new series of measurements that can be stored to the same cells as the previous ones.

6.9.1 Storing measurement results in the memory

Only the results of measurements made with the rotary switch set to the position **2p** or **4p** may be stored in the memory. To do this, follow the steps below:

- Press the key **12** . The currently used bank number and the address of the currently used cell will be displayed on the screen (Fig.24). The border around the bank number means that at least one cell in the bank is occupied. The border around the cell number means that the cell is occupied.

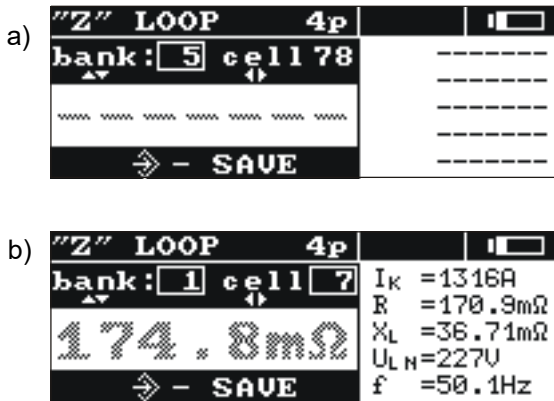











Fig.24. The layout of the screen in the store-in-memory mode: a) empty cell b) cell with the recorded result (the main result is displayed in grey)

- Using the keys  and  select the bank number and using the keys  and  select the cell number or keep the current numbers (recommended if the bank has been erased before the measurements)
- Press the key **12**  again





The main result and its components as well as the values of network voltage, frequency at the time of making the measurement and the network rated voltage, will be stored in the memory.

An attempt to make an entry to the occupied cell will result in a warning signal, instead of the main result, displayed on the screen: **Cell occupied! Overwrite?** Pressing the key **12**  will cause the new result to be saved and the previous one will be lost. In order to cancel the entry and to select another free cell, the user should press the key **14** .

Successful memory entry is signalled with the symbol **19**  displayed on the screen and three short beeps are produced.





While filling the last cell in the given bank, instead of displaying the symbol **19** , the screen will show a text: **Last cell in the bank!**

6.9.2 Memory browsing

In order to view the measurement results stored in the memory, the user should set the rotary switch **9** to the position **MEM**. Choose **Review** from the menu. The screen will display the contents of the recently filled cell (Fig.5). Using the keys  and  the user can select the bank number he/she wishes to review, and using the keys  and  the cell number. If the cell is not filled, horizontal lines will be displayed instead of the memory cell contents.

6.9.3 Erasing the memory

You can erase the whole memory, individual banks or single cells. In order to delete a cell you need to:

- Set the rotary switch **9** to the position **MEM**
- Select **Delete cell**
- Using keys  and  choose the bank number and using keys  and  the cell number you want to delete (Fig.25)

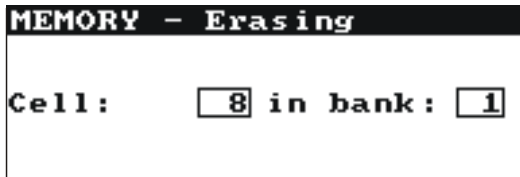







Fig.25. Deleting a memory cell: 1 – bank No, 8 – cell No, **1** – bank with at least one cell used, **8** – a cell in use

- Press the key **12** . The screen will display a prompt asking if you want to erase the cell.
- After selecting the **YES** option, press the key **12** ; the screen will display a message: **Deletion of the selected cell** as well as a progress bar. When deletion is completed a message will be displayed: **Cell deleted!** and the meter will produce three short beeps.

In order to delete an entire bank you need to:

- Set the rotary switch **9** to the **MEM** position
- Select **Bank deletion**
- Using the keys  and  select the bank number

- Press the key **12** . The screen will display a prompt asking if you want to erase the entire bank.
- After selecting the **YES** option, press the key **12** ; the screen will display a message: **Deletion of the whole bank** and a progress bar. When deletion is completed, a message will be displayed: **Bank deleted!** and the meter will produce three short beeps.

In order to delete the whole memory you need to:

- Set the rotary switch **9** to the **MEM** position
- Select **Memory deletion** from the menu
- Press the key **12** . The screen will display a prompt asking whether you want to erase the whole memory

After selecting **YES**, press the key **12** ; the screen will display a message: **Deletion of the whole memory** and a progress bar. When deletion is completed, a message will be displayed: **Whole memory deleted!** and the meter will produce three short beeps.

In order to cancel the deletion, press the key **14** .

6.10 Menu





The menu is available in any position of the rotary switch with the exception of MEM. You can enter the menu by pressing the MENU key. This will give you an access to the following functions:

- Adjustment of the display contrast (0...100%)
- Data transmission via RS232
- Selecting the parameters to be displayed
- Setting the parameters of a loop impedance measurement
- Language selection
- Checking the network stability and upgrading the software – advanced functions
- Obtaining basic information about the manufacturer and about the software version.



By pressing the key **13**  the „Display contrast” option is selected as a default.

6.10.1 Display contrast adjustment

- Press the key **13** .
- Using keys  and  set the required contrast.
- In order to quit this option, press the key **14** .

6.10.2 Data transmission

In order to transfer data between the meter and a PC, you need to:

- Connect the meter to a PC (see Paragraph 6.11.2)
- From the **MENU** select the **Data transmission (RS-232)** option
- Start an appropriate program on the PC

6.10.3 Display settings

In this submenu (Fig.26) the displaying of the following parameters can be selected:

- displaying the results: all of them or Z_s (I_k) only
- displaying the main result in terms of Z_s or I_k

To select parameters use the keys \blacktriangle and \blacktriangledown . To select values use the keys \blacktriangleleft and \blacktriangleright . In order to confirm changes to the settings, select **Save?** and the select **YES** and press the key **12**



Fig.26. MENU – Display settings

6.10.4 Loop measurement settings

In this submenu (Fig.27) the following parameters can be set:

- network rated voltage U_n (220V or 230V)
- length of cables in the measurement of short-circuit loop parameters using a two-pole method (2p)
- measurement of touch voltage U_{ST} or touch shock voltage U_T (and their displaying instead of frequency in the column of auxiliary results).

The selection is made as described in section 6.10.3.

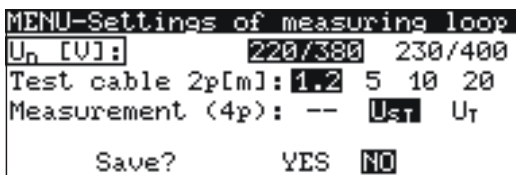

Fig.27. MENU – Loop measurement settings

6.10.5 Language selection

Submenu **Language**, enables the user to select a language that the device will use to display all text.

6.10.6 Advanced functions

a. Expected declension of results

If the result of the short-circuit loop impedance measurement diverges from an anticipated value or there is no consistency of results within a series of measurements made, you may use the function **Expected Declension**. This function can be used to assess errors of loop impedance measurements resulting from the voltage instability at a given measurement point (thus independent of the device parameters). The device (set and connected to the network as for the measurements of short-circuit loop impedance – 2p or 4p) performs the analysis and on its basis it computes the errors values that might additionally burden short-circuit loop impedance measurements.



The function applies to the most recent measurement result only.

After entering this option a short message describing its functionality and a recommendation to get familiarized with this instruction is displayed. After electing **YES** and pressing the key **12** , a picture shown in Fig.28 (for the 4p method) is displayed.

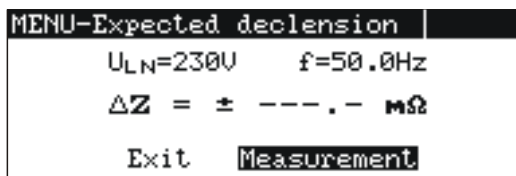





Fig.28. Expected declension

At the top of the screen the values of the currently tested network voltage and frequency are displayed. Underneath the calculated estimate of the error for the measurement method to which the meter is presently set is presented.

In order to start the measurement, select **Measurement** and press the key **12** . The message **Wait, the measurement is going on** and a progress bar will be displayed. When the measurement is completed, the result will be shown (Fig.28 – instead of horizontal lines). By pressing the key **12**  again another measurement will be initiated.

To quit this option, select **Exit** and then press the key **12** . You can also use the key **14** .

b. Upgrading the software

It is possible to upgrade the built-in software without a need to send the meter to a service agent.



NOTE!

The function is intended exclusively for users with a high level of computer literacy. The warranty does not cover any malfunctions of the device that result from incorrect application of this function.

To update the software you need to:



- Download the software from the manufacturer's website
- Connect the meter to the PC
- On the device **MENU** select the function „**Software upgrade**” and confirm that you have read the information displayed.
- Install and then launch the software on the PC.
- Select the port in the program, activate the option „Connection test” and then start the option „Programming”
- Follow the instructions displayed by the software.



NOTE!

- For the duration of the software upgrade operation replace the batteries with the new ones.
- The user must not turn off the meter nor disconnect the communications cables during the procedure.



During the programming operation the keyboard (except for key  ) is inoperative. In this function the meter does not switch off automatically.

6.10.7 Information about the manufacturer and the software

By activating this submenu, the user may obtain the basic information about the meter manufacturer and the software version.

6.11 Sending data to a computer

6.11.1 Communications kit

In order to interface the meter with a computer an optional communications kit is required: a serial cable and appropriate software. If the software package has not been ordered together with the meter, it can be purchased from the manufacturer or from an authorized distributor.

The software package can be used to communicate with a range of instruments manufactured by SONEI S.A. that are equipped with an RS232 connection.

Detailed information about the software is available from the manufacturer and the distributors.

6.11.2 Connecting the meter to a computer

- Connect the communications cable to a serial port (RS-232) of the computer and to the socket **7** of the meter.
- From the **MENU** start the data transmission mode (see Section 6.10.2).
- Start the software.
- Follow the instructions displayed by the program.

7 Troubleshooting

7.1 Warnings and information displayed by the meter

MZC-310S device displays warnings that can be related to either its functioning or to external conditions affecting the measurement processes.

7.1.1 Exceeding the measurement range

Text displayed	Audible signal	Reason	Action
U > 440V!	Continuous	Voltage measured exceeds 440V	Immediately disconnect the meter from the network !
OFL	Two long beeps	Short-circuit loop resistance exceeds 2Ω (4p)	
OFL	Two long beeps	Short-circuit loop resistance exceeds 200Ω (2p)	

7.1.2 Battery status display

Text displayed	Reason	Action
Bat !	Batteries are discharged	Insert new batteries

7.2 Self-test error messages

If, as a result of the self-test, the instrument detects an error, it stops the normal operation and displays an error message. The following messages can appear:

- Internal error
- Damaged FLASH kernel!
- Damaged calibration data



The message that appears may be caused by a momentary interference or an external factor. You should therefore switch the device off and then on to determine if this is the case. If the problem persists, the device should be sent to a service agent.

7.3 Before you send the device for repairs

Before you send the device to a service agent, you should contact the technical support to ensure that the problem is a result of a fault and is not caused by some other factors.

The repairs should be carried out only by service agents authorised by the manufacturer.

In the table below you will find the procedures that should be followed in a case of a malfunction.

Symptom	Reason	Action
The meter does not switch on with the push-button  . While measuring, the symbol  is displayed.	Batteries discharged or inserted incorrectly	Make sure that the batteries are correctly inserted. Replace the batteries. If the problem persists send the device to the service agent.
Consecutive results obtained in the same measuring point differ markedly.	Faulty connection in the installation being tested	Find and remove faulty connections
	Installation with a high level of interference or unstable voltage.	Perform more measurements. Average the results. Use the MENU option: „Expected de- clension" (see section 6.9.6a)
Measurement errors when the device is moved from a cold to a warm and humid environment.	Need for acclimatizing.	Do not use the device until it reaches the ambient temperature (approx. 30 min) and dries out.
The meter shows values close to zero or zero irrespective of the measurement place, and the values deviate considerably from the anticipated values.	Fault in the short circuit loop	Send the device to a service agent.

8 Cleaning and maintenance

The housing of the meter should be cleaned with a soft, damp cloth using a general-purpose detergent. Do not use any solvents or any abrasive cleaning agents.

The electronic system of the meter does not require any maintenance.

9 Storage

When storing the device you should:

- Disconnect all leads from the meter
- Ensure that the device and all accessories are dry
- Ensure that the batteries are removed if the device is not going to be used for a prolonged period of time

Storage should conform to the PN-85/T-06500/08 standard. Storage temperatures listed in the technical specification are acceptable.

10 Decommissioning and recycling

Decommissioned electrical and electronic equipment should be collected separately from any other types of waste.

Decommissioned electronic equipment should be sent to a recycling depot in conformance with waste management guidelines.

Do not remove any components from electronic equipment before sending it to a waste depot.

Local legislation and guidelines regulating disposal of packaging and batteries should be followed.

11 Technical specifications

11.1 Basic data

⇒ The abbreviation „m.v.” in the definition of the accuracy means a standard measured value.

Voltage measurement (True RMS)

Range	Resolution	Accuracy
0...440 V	1 V	±(2% m.v. + 2 digits)

- Frequency range: DC, 45...65 Hz
- Input impedance of the voltmeter: ≥200 kΩ

Frequency measurement (for voltages within the range 50...440 V)

Range	Resolution	Accuracy
45.0...65.0 Hz	0.1 Hz	±(0.1% m.v. + 1 digit)

Short-circuit loop parameters measurement using high current (4p, I_{max}=280 A)

Measurement of short-circuit loop impedance Z_s

Measurement range in accordance with IEC 61557:.....7.2 ÷ 1999 mΩ

Display Range Z_s

Range	Resolution	Accuracy
0.0...199.9 mΩ	0.1 mΩ	±(2% m.v. + 2 mΩ)
200...1999 mΩ	1 mΩ	

Short-circuit resistance R_s and reactance X_s display range

Range	Resolution	Accuracy
0.0...199.9 mΩ	0.1 mΩ	±(2% + 2 mΩ) of the impedance reading for a particular measurement
200...1999 mΩ	1 mΩ	

Short-circuit current readings I_k

Measurement range in accordance with IEC 61557: for U_n = 230 V.....115,0 A ÷ 32,0 kA
for U_n = 400 V.....200 A ÷ 55,7 kA

Display range I_k

Range	Resolution	Accuracy
115.0 A...199.9 A	0.1 A	Calculated from the short-circuit accuracy
200 A...1999 A	1 A	
2.00 kA...19.99 kA	0.01 kA	
20.0 kA...199.9 kA	0.1 kA	
200 kA...*	1 kA	

* 230 kA for U_{LN}
400 kA for U_{LL}

- Prospective fault current calculated and displayed by the meter may slightly differ from the value calculated by the user with a calculator, basing on the displayed value of the impedance, because the meter calculates the current from unrounded value of fault loop impedance (which is used for displaying). As the correct value, consider I_k current value, displayed by the meter or by firmware.

Touch voltage measurement U_{ST} (shock voltage U_T)

Range	Resolution	Accuracy
0...100 V	1 V	±(10% m.v. + 2 digits)

- For U_T – resistor simulating electrical resistance of the human body – 1 kΩ

Measurement of short-circuit loop using standard current (2p, $I_{max}=42$ A)

Measurement of short-circuit loop impedance Z_s

Measurement range in accordance with IEC 61557

Test lead	Z_s measurement range
1.2 m	0.13...199.9 Ω
5 m	0.15...199.9 Ω
10 m	0.19...199.9 Ω
20 m	0.25...199.9 Ω

Display range Z_s

Range	Resolution	Accuracy
0.00...19.99 Ω	0.01 Ω	$\pm(2\%$ m.v. + 3 digits)
20.0...199.9 Ω	0.1 Ω	$\pm(3\%$ m.v. + 3 digits)

Short-circuit resistance R_s and reactance X_s display range

Range	Resolution	Accuracy
0.00...19.99 Ω	0.01 Ω	$\pm(2\%$ + 3 digits) impedance reading for a particular measurement
20.0...199.9 Ω	0.1 Ω	$\pm(3\%$ + 3 digits) impedance reading for a particular measurement

Short-circuit current readings I_K

Measurement Ranges wg IEC 61557

Test lead	I_K measurement range for $U_n = 230$ V	I_K measurement range I_K for $U_n = 400$ V
1.2 m	1.150 A...1849 A	2.00 A ...3,21 kA
5 m	1.150 A...1539 A	2.00 A ...2,67 kA
10 m	1.150 A...1262 A	2.00 A ...2,19 kA
20 m	1.150 A...924 A	2.00 A ...1607 A

Display ranges

Display range	Resolution	Accuracy
1.150 A...1.999 A	0.001 A	Calculated from the short-circuit accuracy
2.00 A...19.99 A	0.01 A	
20.0A...199.9 A	0.1 A	
200 A...1999 A	1 A	
2.00 kA...19.99 kA	0.01 kA	
20.0 kA...40.0 kA	0.1 kA	

- Prospective fault current calculated and displayed by the meter may slightly differ from the value calculated by the user with a calculator, basing on the displayed value of the impedance, because the meter calculates the current from unrounded value of fault loop impedance (which is used for displaying). As the correct value, consider I_K current value, displayed by the meter or by firmware.

Working conditions

- Rated voltage of tested circuits U_n :
Phase voltage 220 V or 230 V
Phase-to-phase voltage 380 V or 400 V
- Voltage range for loop testing 180...440 V
- Rated frequency of tested circuits 50 Hz and 60 Hz (45...65 Hz)

Maximum test current (2p)

- for 230 V +5% 24 A (10 ms)
- for 400 V +5% 42 A (10 ms)

Maximum test current (4p)

- for 230 V +5% 160 A (30 ms)
- for 400 V +5% 280 A (30 ms)

11.2 Other technical data

- a) Insulation class acc. to EN 61010-1 and IEC 61557..... double
- b) Measurement category acc. to EN 61010-1
 - < 2000 m above sea level..... IV 300 V
 - < 3000 m above sea level IV 255 V
- c) Housing protection class as per EN 60529 IP20
- d) Meter power supply R14 alkaline batteries (5 pcs.)
- e) Dimensions 295 x 222 x 95 mm
- f) Weight ca. 2.2 kg
- g) Storage temperature..... -20...+60°C
- h) Operating temperature..... 0...+40°C
- i) Humidity 20%...90%
- j) Rated temperature +20...+25°C
- k) Reference humidity..... 40%...60%
- l) Temperature coefficient ±0.1% of measured value / °C
- m) Time before automatic shutdown 120 sec.
- n) Number of short-circuit loop measurements..... min. 4000 (2 measurements/min.)
- o) Display graphical LCD 192x64 dots
- p) Quality standard development, design and manufacturing to ISO 9001 compliant
- q) The instrument meets the requirement of the IEC 61557 standard
- r) The product meets EMC requirements (immunity for industrial environment) according to the following standards..... EN 61326-1 and EN 61326-2-2

12 Manufacturer

The manufacturer of the device provides all warranty and after-warranty repairs:

SONEL S.A.

Wokulskiego 11
58-100 Świdnica
Poland

tel. +48 74 884 10 53 (Customer Service)

e-mail: customerservice@sonel.com

web page: www.sonel.com



Only the manufacturer is authorized to carry out service repairs.

NOTES

NOTES

NOTES



SONEL S.A.

Wokulskiego 11
58-100 Świdnica
Poland

Customer Service

tel. +48 74 884 10 53
e-mail: customerservice@sonel.com

www.sonel.com